

**Playhouse Set**

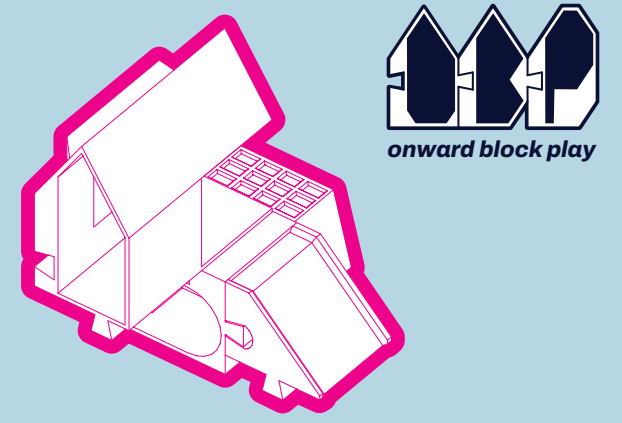

*playhouse set*

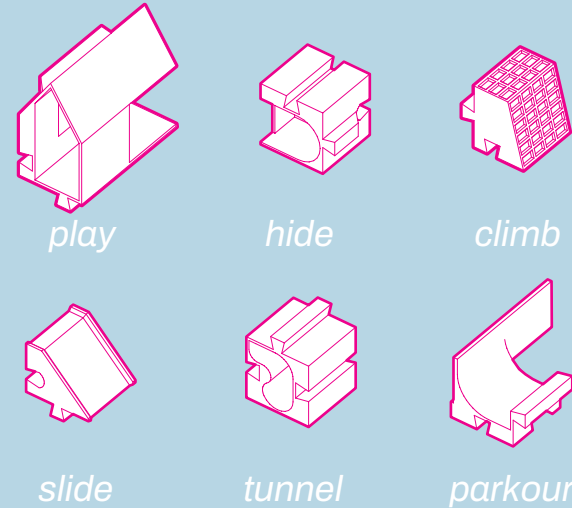
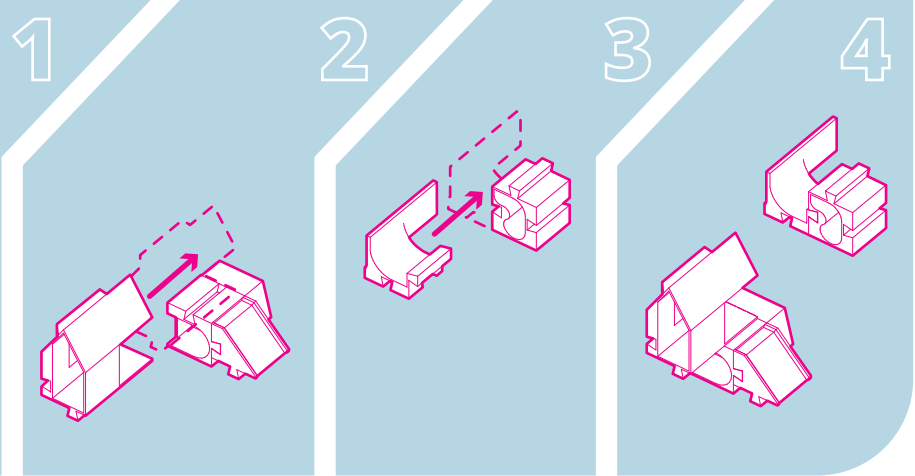

**Nature Set**

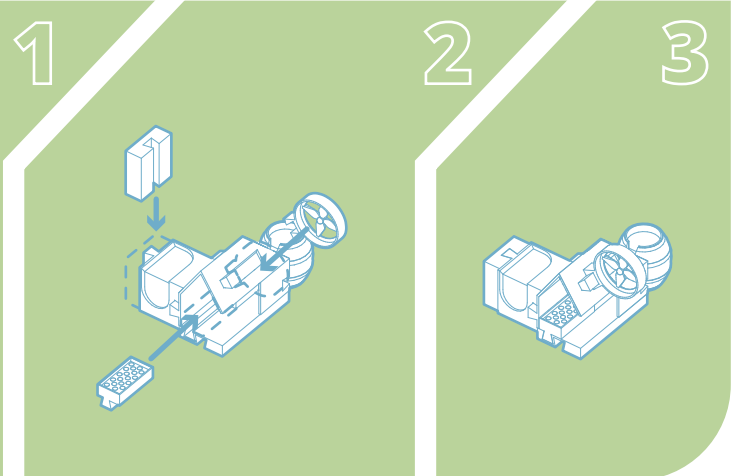

*onward block play*

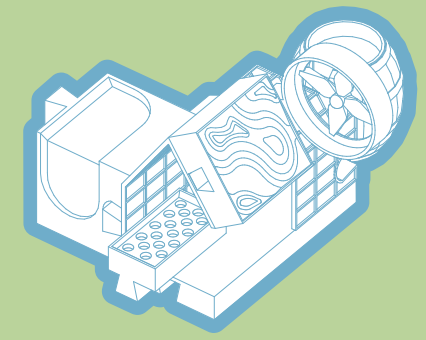

*nature set*

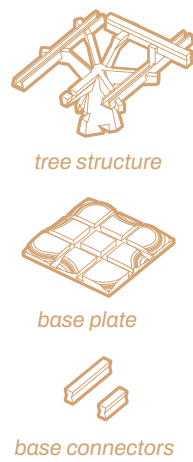

**Tree with Base**

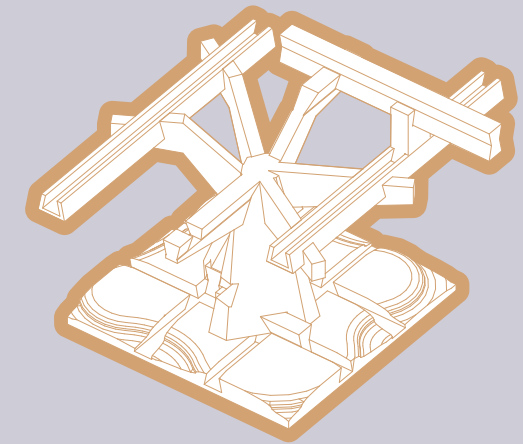
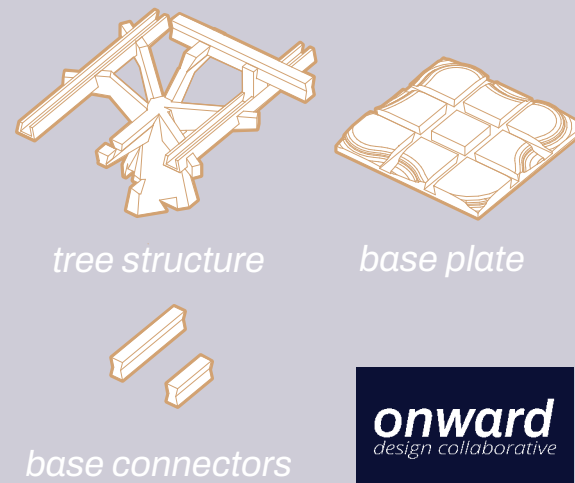
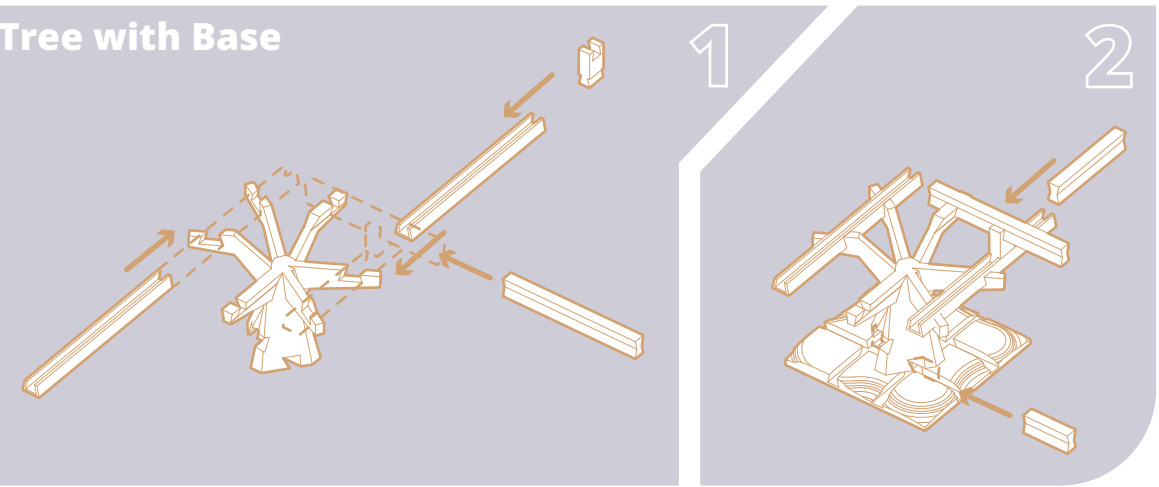

*tree with base*

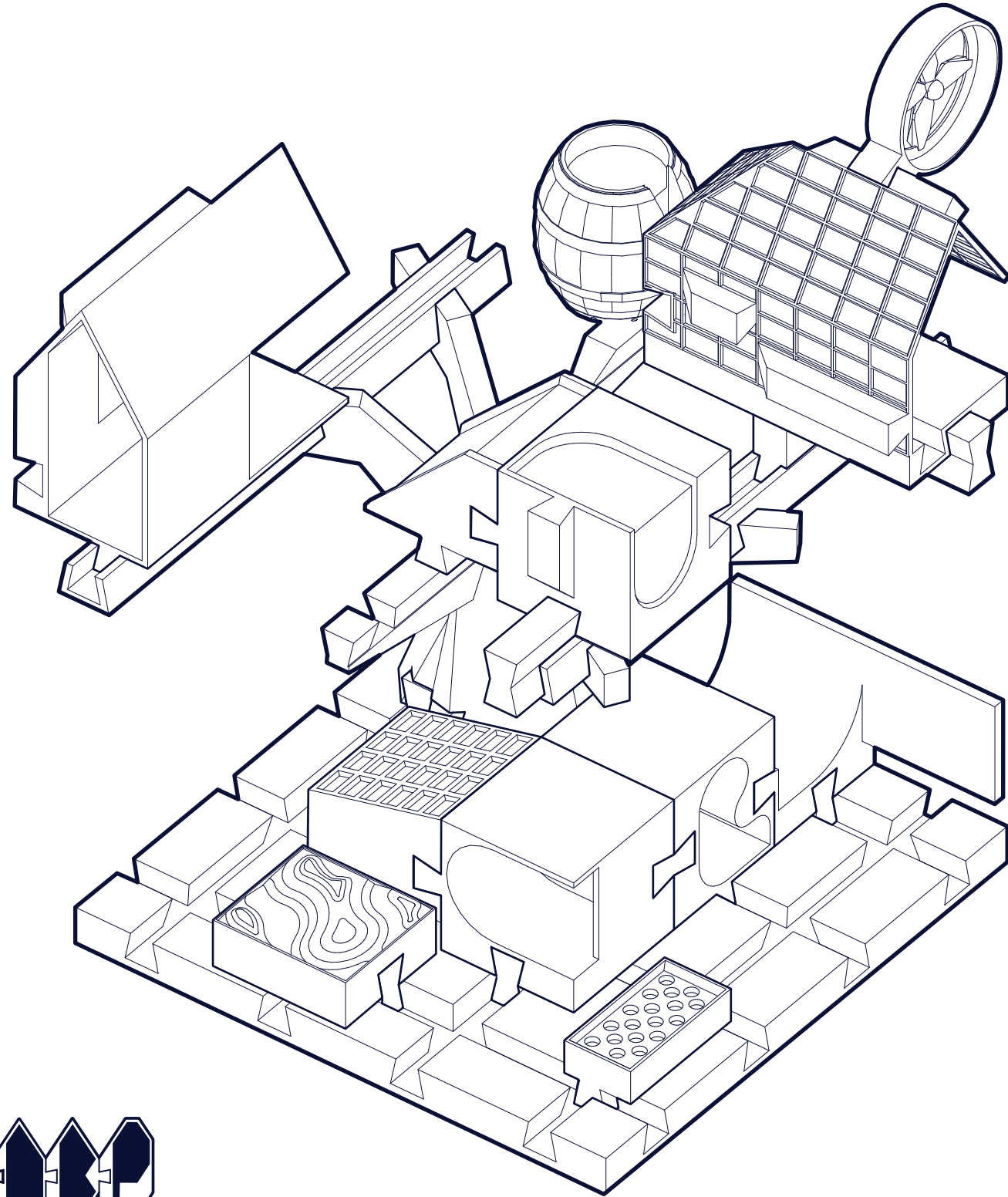

**Playhouse Set**

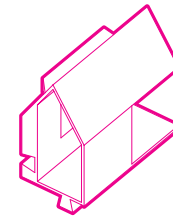

*play*

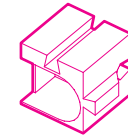

*hide*

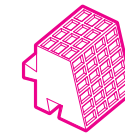

*climb*

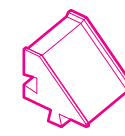

*slide*

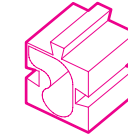

*tunnel*

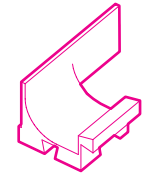

*parkour*

**Nature Set**

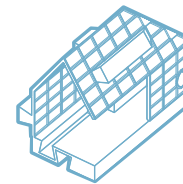

*greenhouse*



*planter box*



*green*



*wind turbine*

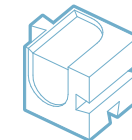

*pool*



*rain barrel*

**Nature Set**

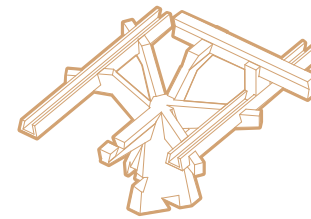

*tree structure*

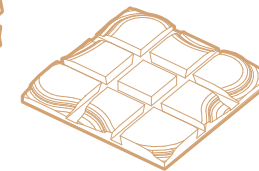

*base plate*

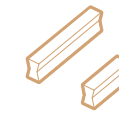

*base connectors*

**Large Base**

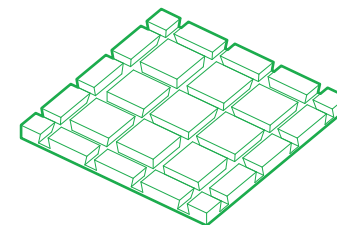

*base plate*

**Connector Pack**

